

# CARLO Aiu, Classic



**beka** DIFFERENT  
BY DESIGN



Watch product video!



Effective floor lift with loop system, made out of durable aluminum!

The electric positioning system (EPS) of the CARLO Alu, Comfort EP enables caregivers to position their residents effortlessly, precisely and without exertion, while always maintaining direct contact.

This way, caregivers are able to devote their full attention to residents, giving them an additional feeling of security while maintaining an ergonomic working posture at the same time. Residents can easily be transferred from a sitting to a lying position and vice versa, allowing for an optimal positioning in bed or over the toilet.

Residents experience a noticeable pressure relief on their legs, especially when lying down. The anti-rotation mechanism (ARM) prevents unwanted rotation of the sling during transfers and reduces unsettling swinging and swaying movements allowing for a single caregiver transfer without sacrificing resident security.

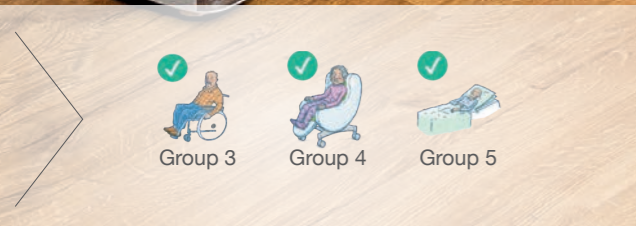

Easy positioning,  
high comfort.

1

### Durable Clip-system hanger bar with 360° rotation range and Anti-Rotation mechanism (ARM)

The hanger bar with the Clip-system has a large, free rotation range of 360° and the anti-rotation mechanism (ARM) prevents uncomfortable pendulum or rotation movements. The ample space between the hanger bar and the column also prevent the residents from coming into contact with the lifting column.

2

### Electric Positioning System (EPS) allowing to switch from Seating to lying position via hand control

The EPS enables residents to be positioned precisely and effortlessly, for example above the toilet or the care bed. You can easily change from a sitting to a lying position (or vice versa).



## Model 185

---

SWL of 185 kg, made out of high quality aluminum, suitable for showering and bathing.



## Model 230

---

For large residents with a SWL of 230 kg. Strong and reliable aluminum and steel construction, with excellent maneuverability.



✓ Lightweight construction, with excellent maneuverability

✓ Lightweight construction, with excellent maneuverability

✓ Anti-rotation mechanism (ARM)

✓ The hanger bar can lower to the floor, easily picking up fallen residents

✓ Closed double castors



Electrical spreadable chassis and height adjustment



Lowering of the hanger bar to the floor



Free 360° rotation range between the hanger bar and the column



Free 360° rotation range between the hanger bar and the column



High quality double castors

# Options

## Low chassis

The low chassis height of 58 mm allows for compatibility with low profile care equipment.



## Digital Scale

The scale can be calibrated with pounds or kilograms. (Picture may vary from due to on-going product enhancement.)



## Different loop systems

- 2-point spreader bar
- 4-point spreader bar
- 4-point flat spreader bar
- 6-point spreader bar



# CARLO Alu series

In addition to the CARLO Alu, Classic series we offer the CARLO Alu, Comfort EP models, that come with a clip attachment system and many advantages. The following table provides a good overview on all CARLO models available at BEKA Hospitec.



CARLO Alu,  
Comfort EP 185



CARLO Alu,  
Comfort EP 230



CARLO Alu,  
Classic 185



CARLO Alu,  
Classic 230

EPS  
(Electric Positioning System)



ARM  
(Anti-Rotation Mechanism)



SWL

185 kg

230 kg

185 kg

230 kg

Material

Aluminum

Aluminum +  
Steel

Aluminum

Aluminum +  
Steel

Sling attachment system

Clip

Clip

Loop

Loop

„I can easily operate the hoist myself, thanks to the clever design.“

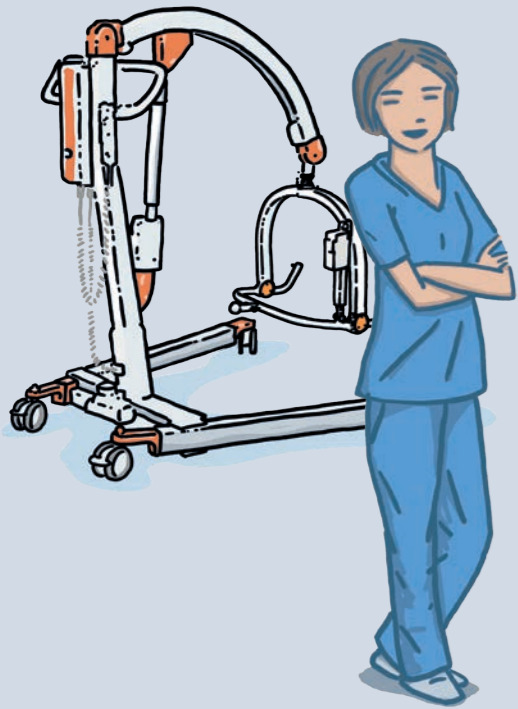

- ✓ Lightweight construction, easy to maneuver
- ✓ EPS for precise positioning of residents without physical effort
- ✓ Easy operation via the hand control with intuitive symbols for all functions and display of battery status
- ✓ Hanger bar with Anti-Rotation mechanism allows easy transfers

Space requirements for CARLO Alu, Comfort EP 185 using an example Planning proposal.

Our mobile lifters such as the CARLO Alu, Comfort EP 185 can be used throughout the facility as they are not fixed in one location. However there are some space requirements that need to be considered to guarantee a problem-free use.

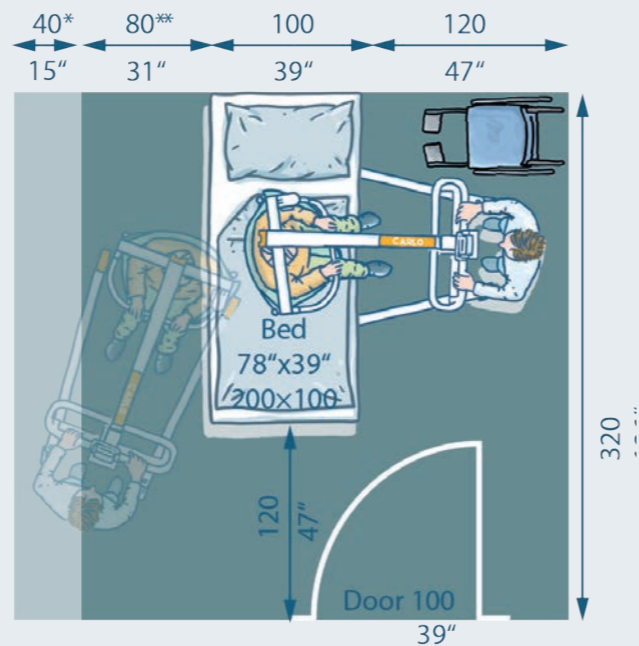



## Technical Data

	Model 185 ●	Model 230 ●
Chassis ( L x H )	1.290 x 125 mm	1.400 mm x 125 mm
Inner leg width ( legs closed/open )	540 / 1.040 mm	540 / 1.100 mm
Outer leg width ( legs closed)	700 mm	700 mm
Lifting range	1.400 mm	1.400 mm
SWL	185 kg	230 kg
Material	Aluminum	Aluminum + Steel





## Product Information

Light and easy to maneuver
Hand control with display of the battery status
Clip-system hanger bar with 360° rotation range
Electric height adjustment and electrically spreadable chassis
Anti-rotation mechanism (ARM)
Different Loop systems available

## Available Options

-  Extra battery 24 V
-  Wall charging unit
-  Digital patient scale
-  Low chassis

## Clip Slings

-  Transfer slings  
With headrest  
Padded leg loops  
High quality nylon material
-  Bathing slings  
With headrest  
Padded leg loops  
High quality nylon-mesh material
-  Toilet slings  
With headrest  
Padded leg loops  
Arm padding
-  Soft slings  
With headrest  
Padded leg loops  
Breathable nylon/cotton blend



**BEKA Hospitec GmbH** | Am Rübenmorgen 3 | 35582 Wetzlar-Dutenhofen  
Tel +49 641 922 20-0 | E-Mail [info@beka-hospitec.com](mailto:info@beka-hospitec.com)  
[www.beka-hospitec.com](http://www.beka-hospitec.com)